

Pyxis®

CR-301 Corrosion Rate Sensor User Manual



Water Professionals Deserve Better Tools.
www.pyxis-lab.com

CR-301 Corrosion Rate Sensor User Manual

May 12, 2021
Rev. 1.03

Pyxis Lab, Inc.
1729 Majestic Dr. Suite 5
Lafayette, CO 80026 USA
www.pyxis-lab.com

Table of Contents

1	Introduction	2
1.1	Features	3
1.2	uPyxis APP Configuration	3
2	Specifications	4
3	Unpacking the Instrument	5
3.1	Standard Accessories	5
3.2	Optional Accessories	5
4	Installation	6
4.1	Wiring	7
4.2	Connecting via Bluetooth	10
5	Instrument Overview	11
5.1	Test Metal Electrodes	11
5.2	Default Sensor Settings	13
5.3	Confirm 4–20mA Output to MPY using the Calibration Check Caps	13
6	Setup and Calibration with uPyxis® Mobile App	14
6.1	Download uPyxis® Mobile App	14
6.2	Connecting to uPyxis® Mobile App	15
6.3	Reading Screen	16
6.4	Setting Screen	17
7	Setup and Calibration with uPyxis® Desktop App	18
7.1	Install uPyxis® Desktop App	18
7.2	Connecting to uPyxis® Desktop App	19
7.3	Information Screen	20
7.4	Reading Screen	20
7.5	Setting Screen	21
8	Outputs	21
8.1	4–20 mA Output Setup	21
8.2	Communication using Modbus RTU	21
9	Sensor Maintenance and Precaution	21
10	Regulatory Approval	22
11	Contact Us	22

Warranty Information

Confidentiality

The information contained in this manual may be confidential and proprietary and is the property of Pyxis Lab, Inc. Information disclosed herein shall not be used to manufacture, construct, or otherwise reproduce the goods described. Information disclosed herein shall not be disclosed to others or made public in any manner without the express written consent of Pyxis Lab, Inc.

Standard Limited Warranty

Pyxis Lab warrants its products for defects in materials and workmanship. Pyxis Lab will, at its option, repair or replace instrument components that prove to be defective with new or remanufactured components (i.e., equivalent to new). The warranty set forth is exclusive and no other warranty, whether written or oral, is expressed or implied.

Warranty Term

The Pyxis warranty term is thirteen (13) months ex-works. In no event shall the standard limited warranty coverage extend beyond thirteen (13) months from original shipment date.

Warranty Service

Damaged or dysfunctional instruments may be returned to Pyxis for repair or replacement. In some instances, replacement instruments may be available for short duration loan or lease.

Pyxis warrants that any labor services provided shall conform to the reasonable standards of technical competency and performance effective at the time of delivery. All service interventions are to be reviewed and authorized as correct and complete at the completion of the service by a customer representative, or designate. Pyxis warrants these services for 30 days after the authorization and will correct any qualifying deficiency in labor provided that the labor service deficiency is exactly related to the originating event. No other remedy, other than the provision of labor services, may be applicable.

Repair components (parts and materials), but not consumables, provided during a repair, or purchased individually, are warranted for 90 days ex-works for materials and workmanship. In no event will the incorporation of a warranted repair component into an instrument extend the whole instrument's warranty beyond its original term.

Warranty Shipping

A Repair Authorization (RA) Number must be obtained from Pyxis Technical Support before any product can be returned to the factory. Pyxis will pay freight charges to ship replacement or repaired products to the customer. The customer shall pay freight charges for returning products to Pyxis. Any product returned to the factory without an RA number will be returned to the customer. To receive an RMA you can generate a request on our website at <https://pyxis-lab.com/request-tech-support/>.

Pyxis Technical Support

Contact Pyxis Technical Support at +1 (866) 203-8397, service@pyxis-lab.com, or by filling out a request for support at <https://pyxis-lab.com/request-tech-support/>.

1 Introduction

The Pyxis CR-301 corrosion sensor measures the metal corrosion rate in an aqueous environment based on the principle of linear polarization resistance (LPR). A small polarization DC voltage is applied to two test metal electrodes and the resulting current is measured by the sensor. The polarization resistance value is calculated from the measured current and the applied polarization voltage. The metal corrosion rate in the unit of thousandths of inch per year (or mils per year, MPY) is then determined as:

$$MPY = B/R_p \quad (1)$$

where R_p is the polarization resistance (LPR) and B the proportional constant.

To calculate R_p originated from the electrochemical reaction at the metal water interface, the CR-301 sensor subtracts the solution resistance R_s due to the test solution conductivity from the total resistance measured between the two test electrodes. The CR-301 sensor accurately measures the test solution conductivity using the two test electrodes and the bipolar pulse technique, which has been successfully used in other Pyxis conductivity sensors and handheld meters.

A challenge of using the LPR method to measure corrosion rate below 0.01 MPY is to measure electric current in the range of pico and nano-amperes. The CR-301 sensor adapts a range of techniques that are practiced in our fluorimeters where low pico ampere current is measured. These techniques include electromagnetic interference shielding, special analog circuit designs and digital signal processing. The proportional constant B has a theoretical value for a given metal type and size. The CR-301 assumes B equal to $1.24 \text{ MPY} \cdot \Omega$ for a 5 cm^2 mild steel electrode, which is a typical value that has been used in many LPR corrosion researches. This proportional constant may be also referred to as the alloy factor of the test metal and normalized to 1.0 for the steel electrode for convenience. It can be adjusted by the user to account for variations in a real application environment.

To determine the corrosion situation of real process equipment is not a simple matter. The corrosion rates for various metal surfaces contacting aqueous fluids in a process depends on many parameters, including the corrosivity pertaining to the chemistry of the aqueous fluid, physical parameters such as temperature and the velocity of the fluid, and the metallurgical composition of the process equipment itself. Because of this, the corrosion rate measured by the CR-301 should not be used alone to predict or assess the real corrosion rate of the process equipment. Nevertheless, the science of using the LPR technique to quantify the corrosion rate has been well established. The corrosion rate measured by the CR-301 sensor can be used to understand the corrosivity trend of the aqueous fluid over a period and its correlation to changes in the process parameters.

Measuring corrosion rate using a weight loss corrosion coupon is still widely practiced in many industry applications. LPR is an instantaneous method compared with the corrosion coupon method. It can indicate a change in corrosion rate in a time scale of a few minutes. In theory, a time averaged corrosion rate measured by the Pyxis LPR sensor should agree with that from the weight loss coupon method if both are practiced according to the common practices known in the industry. For monitoring mild steel corrosion rate in an industrial cooling water system, one could also treat the LPR metal electrode itself as the weight loss corrosion coupon and compare the corrosion rate calculated from the weight loss of the electrode to the averaged LPR corrosion rate in order to calibrate the LPR corrosion rate by adjusting the alloy factor.

The electrochemical noise measurement has long been used to quantify the localized corrosion or pitting corrosion rate. The CR-301 sensor measures the short circuit electric current flowing through the electrodes

between the two LPR measurements. The Pyxis sensor first applies a signal process algorithm to remove high frequency noise in the acquired electrochemical current data for a period of 3 minutes and then calculates the standard deviation of the processed data set. The standard deviation calculated is scaled to generate a localized corrosion index. In such a scaling, the index value for a 304-stainless steel electrode immersed in a 10% ferric chloride solution at 72°F is arbitrarily defined as 100. The real time electrochemical current noise data are graphically displayed in the Pyxis display panel, an optional item that can be purchased separately. With the graphic trend, the noise pattern and magnitude can be easily analyzed visually.

1.1 Features

The CR-301 is a standalone high temperature and high pressure rated LPR corrosion sensor that can be powered by a 24 VDC power source such as an existing controller, PLC or DCS. The sensor is composed of Titanium and PEEK (Polyether Ether Ketone) making it highly resilient to extreme process environments, temperatures and pressures. The CR-301 also offers an expanded general corrosion range as high as 995 mils per year and localized corrosion index as high as 100.

When used with the provided MA-CR Pyxis Bluetooth Adapter, the CR-301 must be configured via the uPyxis APP for Mobile or Desktop devices. The uPyxis app is used to configure the CR-301 for the metallurgy desired, assign a sensor identification name, obtain live sensor readings. Default measurement ranges and alloy factors will be applied to the CR-301 via the uPyxis APP when the user selects the metallurgy desired. Custom alloy factors and ranges of measurement may be adjusted if desired. Additional diagnostic information is available and can be used for determining the sensor performance or the need for maintenance.

- Anti-electromagnetic interference (anti-EMI) design with Titanium sensor body
- 2x 4–20mA Outputs (General Corrosion and Localized Corrosion)
- RS-485 Modbus Output
- Integrated Cooling Fin Design for High Temperature Applications
- Bluetooth connectivity to uPyxis app when used with MA-CR Adapter
- Default 4–20mA Output scales and Alloy Factors assigned for selected metallurgy via uPyxis
- Customization of Alloy Factor and upper MPY / Index (20mA) scale as desired via uPyxis
- Ultra-low general corrosion rate detection down to 0.001 MPY

1.2 uPyxis APP Configuration

The uPyxis APP manages all Pyxis portable meter and inline sensors on mobile and desktop devices, including Apple iPhones and Samsung Android smartphones. When connected to the Pyxis CR series corrosion rate sensors, the uPyxis APP enables users to configure the sensor for the specific metallurgy desired as well as name the sensor, system and data log frequency in addition to offering live corrosion rate data trending. For wireless access to CR-301, the MA-CR Bluetooth Adapter will be required. One MA-CR adapter is provided with the purchase of each CR-301.

NOTE *The uPyxis Mobile APP is evolving rapidly and users can find the latest version at no cost on Apple iStore or Google Play. The uPyxis Desktop APP may be downloaded at <https://pyxis-lab.com/upyxis/>*

2 Specifications

Table 1. CR-301 Specifications

Item	CR-301	CR-301-BSP
P/N	51021	51026
General Corrosion Range - MPY (4-20mA Output)	0.001-995 (Default Assigned MPY is Customizable Via uPyxis)	
Resolution	0.001 MPY or 1% of Reading	
Localized Corrosion Range – Index (4-20mA Output)	0.001-100 (Default Assigned Index is Customizable Via uPyxis)	
Conductivity Compensation	10-50,000uS/cm	
Reading Interval	3 to 1440 Minutes (>3 Minutes Required for Localized Corrosion Data)	
Alloy Factor Range	0 – 3 (Adjustable Default Assigned via uPyxis on Metallurgy UNS Code)	
Power Supply	24V DC, 2W	
Output	RS-485 and 4-20 mA Dual Output	
Weight	1150g	
Dimensions (L x D)	280mm L X 52mm D	
Installation	¾-inch MNPT	¾-inch BSPT
Enclosure Material	Titanium + PEEK	
Operating Pressure	Up to 500 psi (34.5 bar)	
Operating Temperature	-10 – 240°C (14 – 464°F)	
Storage Temperature	-20 – 70°C (-4 – 158°F)	
Cable Format	8Pin - 5 ft. (1.5 m), (Extension Cables Available)	
Protection	IP68	
Regulation	CE / RoHS	

3 Unpacking the Instrument

Remove the instrument and find the standard accessories from the shipping container as listed below. Inspect each item for any damage that may have occurred during shipping. Verify that all accessory items are included. If any item is missing or damaged, please contact Pyxis Lab Customer Service at service@pyxis-lab.com

3.1 Standard Accessories

3.1.1 CR-301 - Wired / 24VDC LPR Corrosion Sensor Package (P/N 51021)

- The package should include one CR-301 sensor, a 5-foot extension cable terminated with connectors, a 2-foot flying lead cable with one end terminated with a connector
- One Bluetooth Adapter for CR-301 (P/N: MA-CR)
- One Bluetooth Adapter for PC (P/N: MA-NEB)
- One pair of copper (P/N: 51003) and one pair of mild steel electrodes (P/N: 51002)
- One 2.0 MPY Calibration Check/verification cap (P/N: 51010)
- One 0.1 MPY Calibration Check/verification cap (P/N: 51011)
- Operation Manual is also available for download at <https://pyxis-lab.com/support/>

3.2 Optional Accessories







 PYXIS CORROSION SENSOR ACCESSORIES 		
Accessory Name / Description	Part #	Photo
MA-10CR - 10' Cable for CR300 LPR Sensor	50741	
MA-20CR - 20' Cable for CR300 LPR Sensor	50742	
MA-50CR - 50' Cable for CR300 LPR Sensor	50743	
MA-100CR - 100' Cable for CR300 LPR Sensor	50744	
MA-4.9CR - 4.9' Cable For CR300 LPR Sensor	50745	
MA-1.5CR - 1.5 Meter Connection Cable For CR300 w Flying Leads	50746	
CR-200 3.6V ER26500 Battery	50730	
2.0 MPY Calibration Cap	51010	
0.1 MPY Calibration Cap	51011	
CR-Series Bluetooth Adapter - 8Pin	MA-CR	
CE-01 Mild Steel Electrode Pair	51002	
CE-02 Copper Electrode Pair	51003	
<p><i>*NOTE* Pyxis Lab does not manufacture LPR electrodes. Some electrodes are provided by Pyxis Lab from Metal Samples as a convenience. UNS Codes for each electrode format are provided in the Test Metal Electrodes section. Users may purchase these electrodes directly from Metal Samples at https://www.alspi.com/ms.htm.</i></p>		

Figure 1.

4 Installation

The CR-301 sensor is shipped without the electrodes installed. A pair of copper and mild steel electrodes are included in the package. Remove the O-rings in the electrode package and place an O-ring to each threaded rod on the sensor. Fasten the electrodes to the threaded rods to slightly compress the O-ring on the bottom of the threaded rod. Clean the electrodes with isopropanol to remove any oil or other foreign materials on the electrode surfaces.

NOTE Pyxis recommends wearing latex gloves when installing the electrodes to avoid contamination with skin oils.



Figure 2. CR-301 Installation in the sample flow line

The sensor probe shall be inserted into a pipe via a 3/4 - inch threaded tee. The corrosion rate measured by the CR-301 sensor may be affected by the position of the two-test metal electrodes in relation to the water flow. The electrodes should be fully immersed in the water sample and away from any turbulence. For the best performance, the two-test metal electrodes should be installed to be parallel to the flow and maintain a symmetry between the electrodes with respect to the flow environment as much as possible.

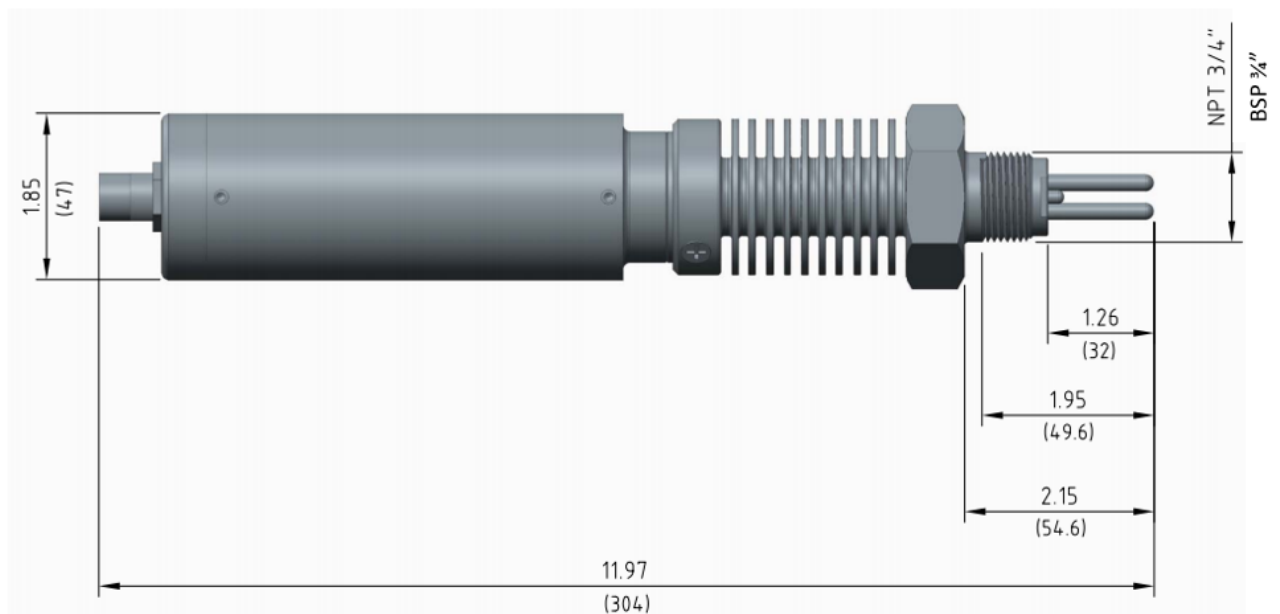

Figure 3. CR-301 Dimensions in Inch (mm)

4.1 Wiring

Follow the wiring table below to connect the CR-301 sensor to a controller. The Grey wire and the Brown wire are the power ground and internally connected. The Grey wire can be used for the 4–20 mA return. The Blue and Yellow wires are for RS-485 connection only and only required if using Modbus protocol. The Green earth ground wire should be connected to the controller chassis ground if it is available.

Table 2.

Wire Color	Designation
Red	24V +
Brown	24V Power ground
White	General corrosion rate, 4–20mA +
Pink	Localized corrosion rate, 4–20mA +
Gray*	4–20mA -
Blue	RS-485 A
Yellow	RS-485 B
Green	Shield, earth ground

* Internally connected to the power ground

The CR-301 comes with 4–20mA transmitters embedded in the sensor body. It provides outputs on two channels of 4–20mA signals that represent general corrosion rate and localized corrosion rate respectively. Default alloy factors and corrosion rate scales in mils per year (MPY) are pre-programmed for each metallurgy in the uPyxis APP as outlined in the **Test Metal Electrode Default Settings** table. When a metallurgy is selected from the drop-down list, the uPyxis APP will automatically assign default alloy factor and 4–20mA scales for both general and localized corrosion. The corrosion rates scales provided by uPyxis are commonly appropriate for the range of typical corrosion observed of the selected metallurgy, however, the user may desire to alter the alloy factor or corrosion rate scale for any selected metallurgy in the uPyxis APP.

The user may alter the 4–20 mA output from the CR-301 to a desired corrosion rate in the unit of MPY by setting up one of three configurable parameters. The configurable parameters include 1) alloy factor, 2) the sensor's 4–20 mA range and 3) the controller's 4–20 mA range. The first two reside in the CR-301 sensor itself and can be configured by using the uPyxis app.

See below for wiring illustrations of the CR-301 sensor to several common controllers.

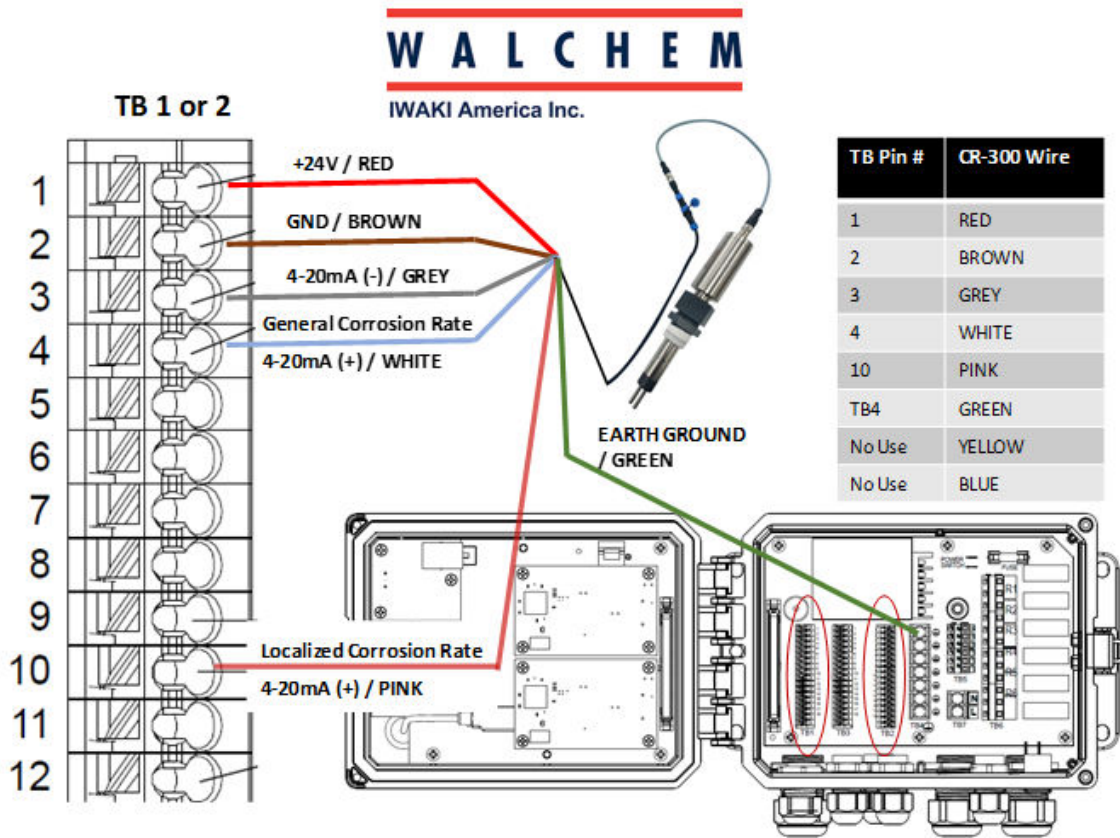

Figure 4. Typical wiring for WalChem W600

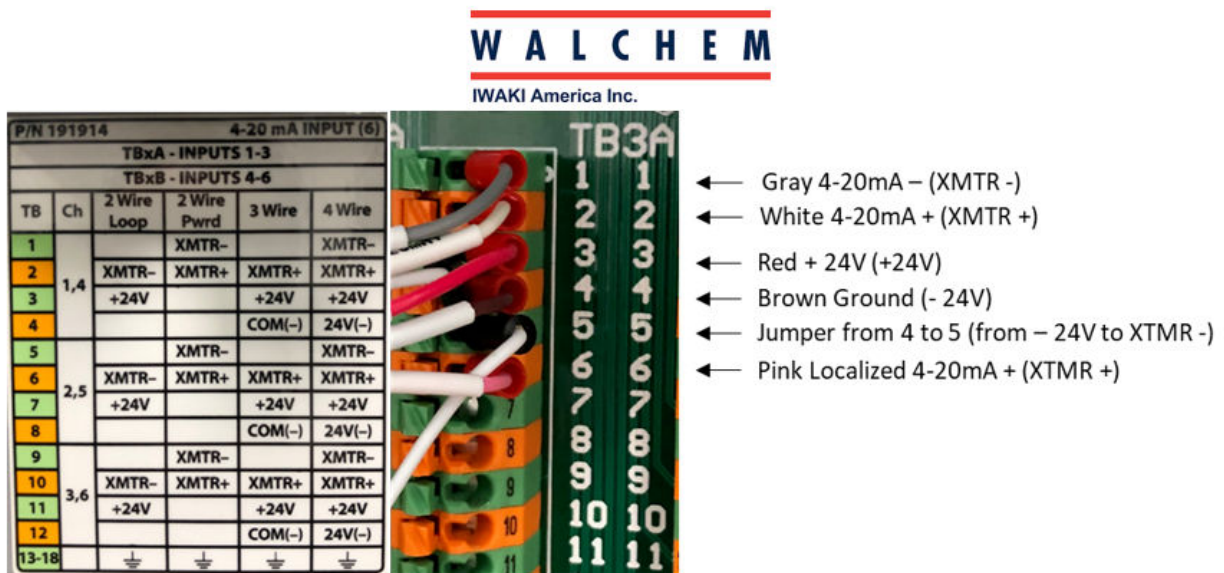

Figure 5. Typical wiring for WalChem W900 (4-wire loop configuration)

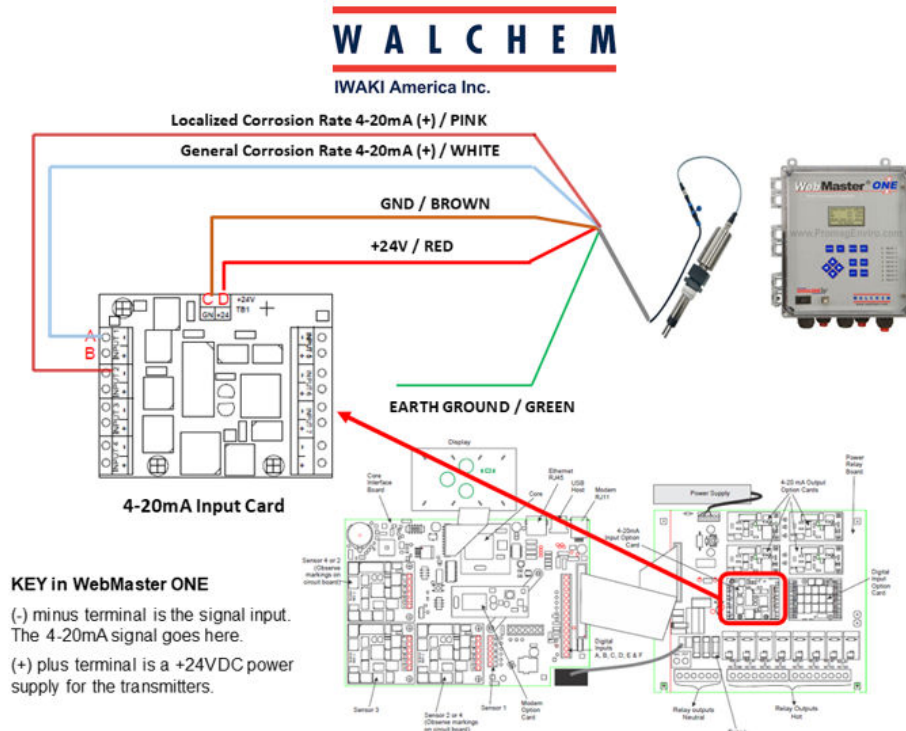

Figure 6. Typical wiring for WalChem WebMaster One

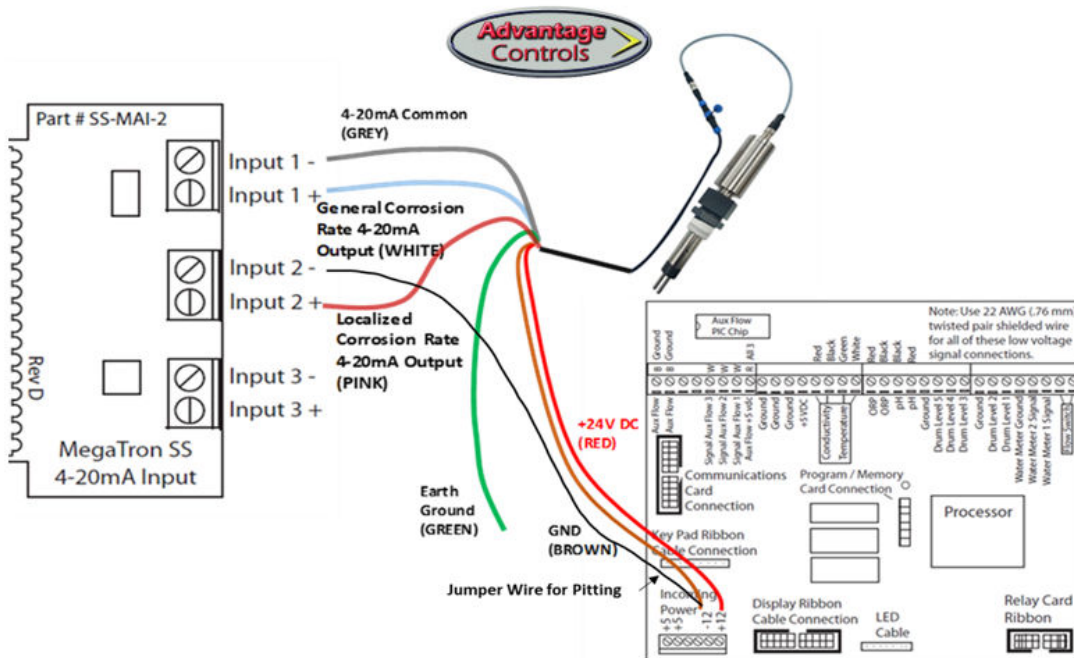

Figure 7. Typical wiring for Advantage Controls MegaTron SS

NOTE To get a Pitting signal, a jumper wire is needed from 4-20mA Input 2- to power -24V.

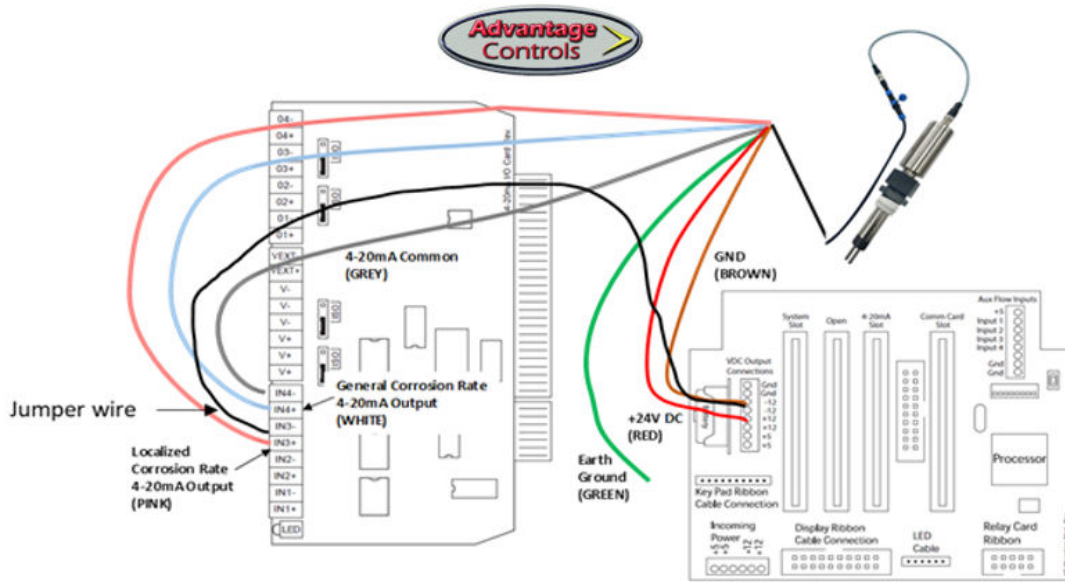

Figure 8. Typical wiring for Advantage Controls MegaTronXS

NOTE To get a Pitting signal, a jumper wire is needed from 4–20mA Input 3- to power -24V.

4.2 Connecting via Bluetooth

A Bluetooth adapter (P/N: MA-CR) can be used to connect the CR-301 sensor to a smart phone with the **uPyxis®** Mobile App or a computer with the **uPyxis®** Desktop App. The power should be sourced from a 24 VDC power terminal of a controller. If a controller is not available, the user may also use Pyxis PowerPACK-1 or PowerPACK-4 as an alternative to both an external power supply and a Bluetooth adapter. PowerPACK from Pyxis Lab offers external power, Input/Output signal, and Bluetooth connectivity.



Figure 9. Bluetooth connection to CR-301 sensor

5 Instrument Overview

5.1 Test Metal Electrodes

Pyxis provides 5-cm² (0.736 square inch) metal electrodes, commonly used in the LPR corrosion measurement applications. The common names, UNS codes, and alloy factors are listed the table below.

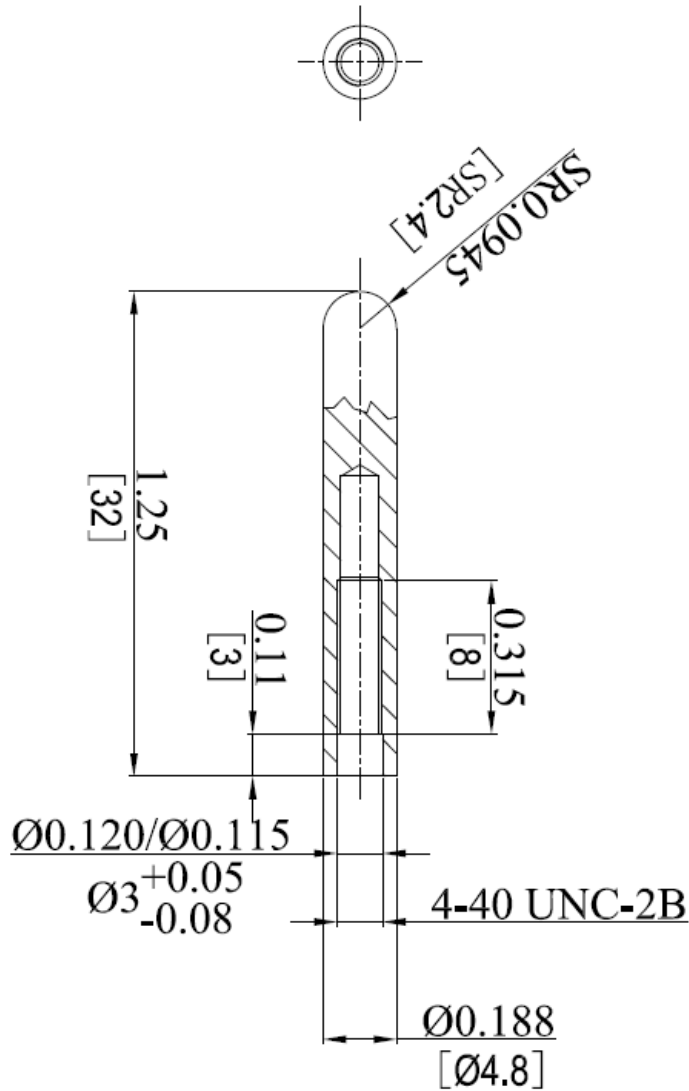

Figure 10. Test Metal Electrode Dimensions, Inch [mm]

Table 3. Test Metal Electrode Default Settings

Common Designation	UNS	Alloy Factor	Default 4–20mA General Corrosion Scale (MPY)	Default 4–20mA Localized Corrosion Scale (Index)
Aluminum AA1100	A91100	0.94	0–50	0–100
Aluminum AA6061	A96061	0.94	0–50	0–100
Aluminum AA2024	A92024	0.86	0–50	0–100
Cu/Ni - 70/30	C71500	1.50	0–5	0–10
Copper 110 ETP	C11000	2.00	0–5	0–10
CDA 687 Aluminum Brass Arsenical	C68700	1.62	0–5	0–10
CDA 642 Aluminum Silicon Bronze	C64200	1.48	0–5	0–10
Arsenical Admiralty Brass CDA443	C44300	1.67	0–5	0–10
Phosphorized Admiralty Brass CD445	C44500	1.68	0–5	0–10
Pipe Grade Carbon Steel	A135	1.00	0–50	0–100
Mild Steel C1010	G10100	1.00	0–50	0–100
Mild Steel C1015	G10150	1.00	0–50	0–100
Mild Steel C1018-C1020	G10180	1.00	0–50	0–100
Mild Steel C1080	G10800	1.00	0–50	0–100
Stainless Steel 304	S30400	0.89	0–2.5	0–10
Stainless Steel 304L	S30403	0.89	0–2.5	0–10
Stainless Steel 316	S31600	0.90	0–2.5	0–10
Stainless Steel 316L	S31603	0.90	0–2.5	0–10
Duplex Stainless 2205 - F51	S31803	0.90	0–2.5	0–10
Duplex Stainless 2507 - F53	S32750	0.90	0–2.5	0–10
Common Lead	L50045	2.57	0–2.5	0–1

NOTE Metal electrodes with a different length and a slightly different diameter may be used with the CR-301 sensor if the electrodes have a 4-40 internal thread and has a surface area of 5 cm². The alloy factor for a given metal alloy is proportional to the surface area of the electrode. If an electrode with a surface area different than 5 cm² (0.736 square inch) is used, the user will need to calculate the proper alloy factor according to the surface area and the default 5cm² alloy factor listed above.

5.2 Default Sensor Settings

The default 4–20 mA current outputs for mild steel are scaled as:

- 4 mA = 0 MPY or 0 localized corrosion index
- 20 mA = 50 MPY (general corrosion)
- 20 mA = 100 Index (localized corrosion)

The sensor is configured to measure the corrosion of mild steel by default. A default alloy factor and output scales for both general and localized corrosion will be assigned by uPyxis. These values may be altered by the user if desired. For measuring the corrosion rate of steel, the user just needs to scale 20 mA = 50 MPY in the controller. Please refer to the **Test Metal Electrode Default Settings** table for a list of all metallurgies and preprogrammed default alloy factors and 4–20mA output scales.

5.3 Confirm 4–20mA Output to MPY using the Calibration Check Caps

The CR-301 is provided with one 2.0 MPY and one 0.1 MPY- calibration check/verification caps. These caps are designed to generate a known MPY value when connected to the uPyxis APP and when the sensor is configured with the uPyxis Default Settings assigned. These corrosion verification caps will work regardless of which metallurgy is applied to the corrosion sensor and simply establish a known electrical current to “simulate” a specific MPY value. When the controller is scaled to match the uPyxis default settings, these caps will generate a “TEST” signal to confirm the controller reads properly.

NOTE Please note that when conducting a test with the calibration verification caps, the user should allow up to 15 minutes for the final corrosion value to stabilize.

Follow the steps below to configure the controller’s 4–20 mA range:

1. Install two new test electrodes (example Steel or Copper)
2. Plug the sensor to the calibration appropriate calibration check cap and wait for at least for 15 minutes to allow the sensor to carry out three complete measurements (Figure ??).
3. Confirm the controller’s analog input 4–20mA scale is programmed correctly so that the corrosion rate value on the controller matches with the value marked on the calibration cap.



Figure 11. Plug the sensor into the calibration check cap

6 Setup and Calibration with uPyxis® Mobile App

The default configuration of the CR-301 sensor before shipping is to measure the corrosion rate of mild steel. The alloy factor was set to be the theoretical value of iron. The sensor can be configured for other metals with appropriate alloy factors and the 4–20mA scale settings for general and localized corrosion rates using the uPyxis® Mobile or Desktop App.

6.1 Download uPyxis® Mobile App

Download uPyxis® Mobile App from [Apple App Store](#) or [Google Play](#).



Figure 12. uPyxis® Mobile App installation

6.2 Connecting to uPyxis® Mobile App

Connect the CR-301 sensor to a mobile smart phone according to the following steps:

1. Open **uPyxis®** Mobile App.
2. On **uPyxis®** Mobile App, pull down to refresh the list of available Pyxis devices.
3. If the connection is successful, the CR-301 and its Serial Number (SN) will be displayed (Figure 13).
4. Press on the **CR-301 sensor image**.

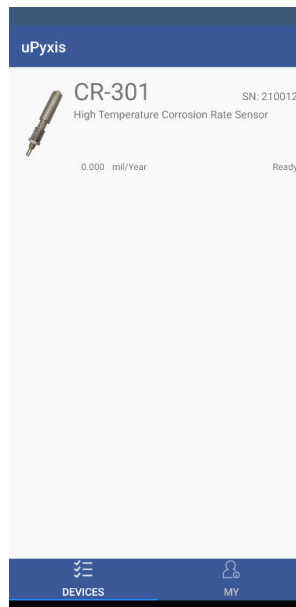

Figure 13.

6.3 Reading Screen

When connected, the **uPyxis**® Mobile App will default to the **Reading** screen. From the **Reading** screen, you can perform a calibration by pressing on **Slope Calibration**. Follow the screen instructions for each calibration step.

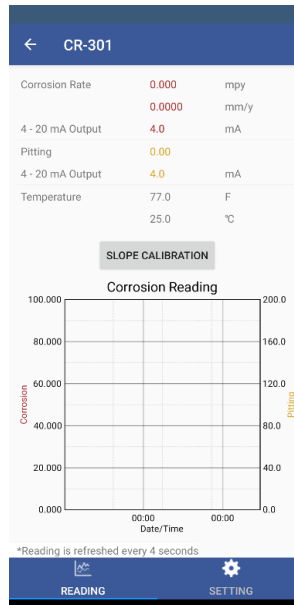

Figure 14.

6.4 Setting Screen

From the **Setting** screen, you can set the **Reading Interval**, the **Metal Selection**, the corrosion MPY value for 20 mA, the pitting value for 20 mA, two smoothing factors, and a password for the device. Be sure to press **Apply Settings** to save any changes.

← CR-301

Reading Interval: 3 minutes

Alloy Factor

Metal Selection: Mild Steel C1010 / G10100

Alloy Factor: 1

Corrosion 4 - 20 mA

0 mpy = 4 mA

50.000 mpy = 20 mA

Pitting 4 - 20 mA

0 = 4 mA

100.00 = 20 mA

Smoothing Factor

Smoothing Factor 1: 0.7

Smoothing Factor 2: 0.7

APPLY SETTINGS

READING SETTING

Figure 15.

7 Setup and Calibration with uPyxis® Desktop App

The default configuration of the CR-301 sensor before shipping is to measure the corrosion rate of mild steel. The alloy factor was set to be the theoretical value of iron. The sensor can be configured for other metals with appropriate alloy factors and the 4–20mA scale settings for general and localized corrosion rates using the **uPyxis®** Mobile or Desktop App.

7.1 Install uPyxis® Desktop App

Download the latest version of **uPyxis®** Desktop software package from: <https://pyxis-lab.com/upyxis/> this setup package will download and install the Microsoft.Net Framework 4.5 (if not previously installed on the PC), the USB driver for the USB-Bluetooth adapter (MA-NEB), the USB-RS485 adapter (MA-485), and the main **uPyxis®** Desktop application. Double click the **uPyxis.Setup.exe** file to install.

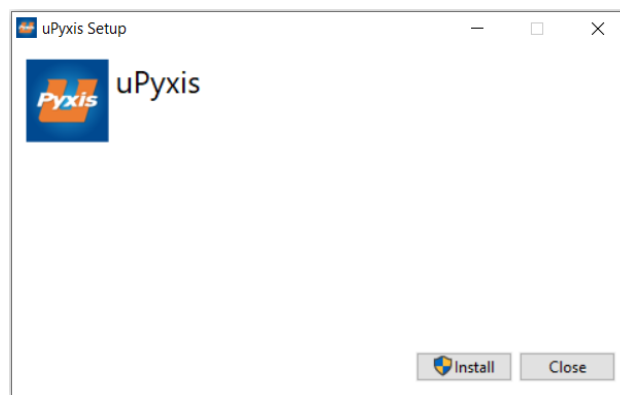

Figure 16. uPyxis® Desktop App installation

Click **Install** to start the installation process. Follow the screen instructions to complete the USB driver and **uPyxis®** installation.

7.2 Connecting to uPyxis® Desktop App

Connect the CR-301 sensor to a Windows computer using a Bluetooth/USB adapter (P/N: MA-NEB) according to the following steps:

1. Plug the Bluetooth/USB adapter into a USB port in the computer.
2. Launch uPyxis® Desktop App.
3. On uPyxis® Desktop App, click Device → **Connect via USB-Bluetooth** (Figure 17).
4. If the connection is successful, the CR-301 and its Serial Number (SN) will be displayed in the left pane of the uPyxis® window.

NOTE After the sensor and Bluetooth is powered up, it may take up to 10 seconds for the adapter to establish the wireless signal for communication.

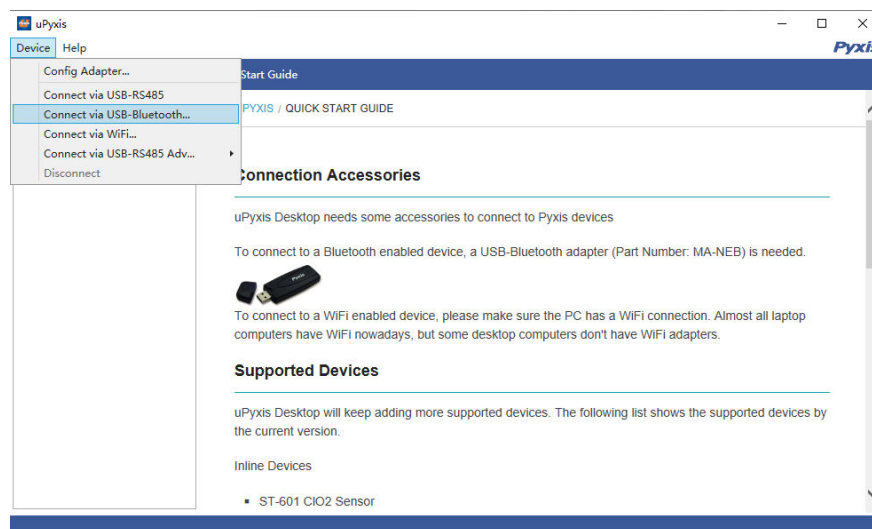

Figure 17.

7.3 Information Screen

Once connected to the device, a picture of the device will appear on the top left corner of the window and the uPyxis® Desktop App will default to the **Information** screen. On the **Information** screen you can set the **Modbus Address**, then click **Apply Settings** to save.

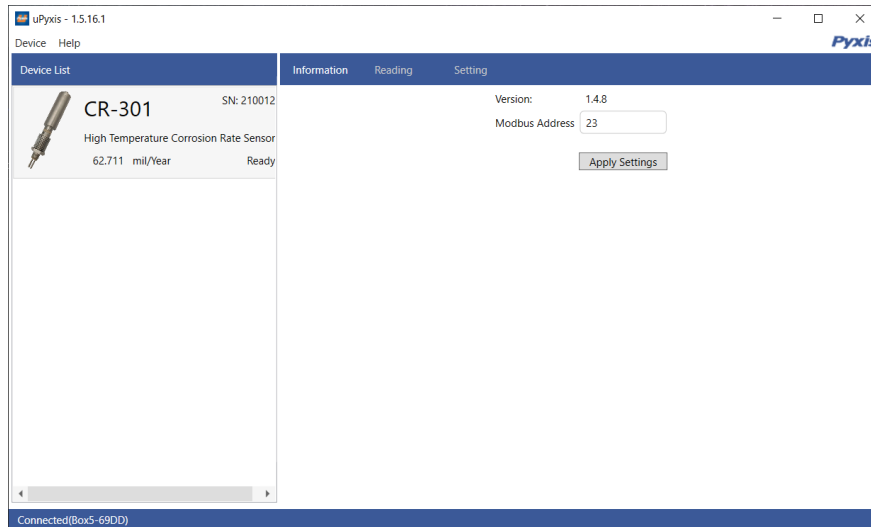

Figure 18.

7.4 Reading Screen

From the **Reading Screen**, you can view the current corrosion and pitting data as well as the trend data.

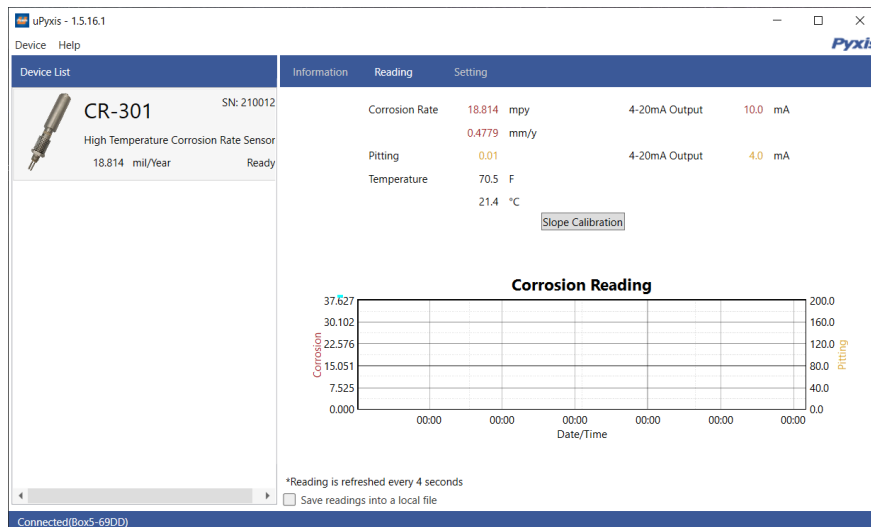

Figure 19.

7.5 Setting Screen

From the **Setting** screen, you can set the **Reading Interval**, the **Metal Selection**, the corrosion MPY value for 20 mA, the pitting value for 20 mA, and two smoothing factors. Be sure to click **Apply Settings** to save any changes.

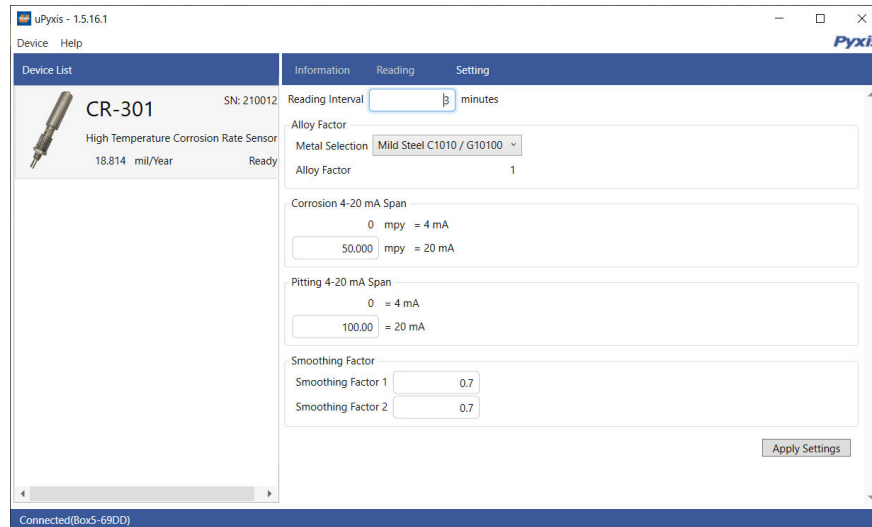

Figure 20.

8 Outputs

8.1 4–20 mA Output Setup

The default setting for the steel general corrosion rate 4–20 mA output is 20 mA = 50 MPY and 4 mA = 0 MPY. The default setting for the steel pitting index is 20 mA = 100 Index and 4 mA = 0 Index. The user can alter the 4–20 mA scale as desired by filling the fields shown in Figures 15 and 20.

As outlined in the **Test Metal Electrode Default Settings**, each pre-loaded metallurgy will offer a default 4–20mA scale for both general and localized corrosion. User may adjust as desired.

8.2 Communication using Modbus RTU

The CR-301 can be configured as a Modbus slave device. In addition to the general corrosion rate and localized corrosion index, many operational parameters, including warning and error messages, are available via a Modbus RTU connection.

Contact Pyxis Lab Customer Service (service@pyxis-lab.com) for more information.

9 Sensor Maintenance and Precaution

For best performance, severely corroded sensor metal electrodes should be replaced. Any deposit on the sensor body and near the base area of the metal electrode should be cleared. Minor corrosion product deposit on the electrode surface is acceptable. Non-corrosion product deposit such as calcium carbonate scale should be removed. The sensor should not be left in stagnant water for a long period unless measuring corrosion rate of the metal in such condition is the purpose for evaluation.

10 Regulatory Approval

United States

The CR-301 sensor has been tested and found to comply with the limits for a Class B digital device, pursuant to part 15 of the FCC Rules. These limits are designed to provide reasonable protection against harmful interference in a residential installation. This equipment generates, uses and can radiate radio frequency energy, and if not installed and used in accordance with the instructions, may cause harmful interference to radio communications. However, there is no guarantee that interference will not occur in an installation. If this equipment does cause harmful interference to radio or television reception, which can be determined by turning the equipment off and on, the user is encouraged to try to correct the interference by one or more of the following measures:

- Reorient or relocate the receiving antenna.
- Increase the separation between the equipment and receiver.
- Connect the equipment into an outlet on a circuit different from that to which the receiver is connected.
- Consult the dealer or an experienced radio/TV technician for help.

Canada

This device complies with Industry Canada license exempt RSS standard(s). Operation is subject to the following two conditions: (1) this device may not cause interference, and (2) this device must accept any interference, including interference that may cause undesired operation of the device. Le présent appareil est conforme aux CNR d'Industrie Canada applicables aux appareils radio exempts de licence. L'exploitation est autorisée aux deux conditions suivantes: (1) l'appareil ne doit pas produire de brouillage, et (2) l'utilisateur de l'appareil doit accepter tout brouillage radioélectrique subi, même si le brouillage est susceptible

11 Contact Us

Pyxis Lab, Inc

1729 Majestic Dr. Suite 5

Lafayette, CO 80026 USA

www.pyxis-lab.com

Phone: +1 (866) 203-8397

Email: service@pyxis-lab.com